

RONDADESIGN.IT

NEVER STOP CREATING

APP DESIGN S.R.L.

Via G. Galilei, 31 - 36010 Zané (VI) - Italy  
Tel. +39 0445 1850142 - Fax +39 0445 1850143  
sales@rondadesign.it



magnetika

KITCHEN & BATHROOM

rondadesign >

rondadesign >

## SCHIENALI CUCINA

Gli schienali cucina di tipo **1.0** sono realizzati in metallo verniciato, in acciaio inossidabile oppure in fenix. Sugli schienali di tipo **1.0** si possono applicare tutti gli accessori e le mensole della collezione Magnetika.

1.0

Magneti base  
Basic magnets

**SCHIENALE IN METALLO**  
METAL BACKSPLASH

SP. 1,5 mm



**SCHIENALE IN FENIX**  
FENIX BACKSPLASH



## KITCHEN BACKSPLASHES

The **1.0** kitchen backsplashes are made of painted metal, stainless steel or fenix. The **1.0** backsplashes can be combined with any accessory and shelf of the Magnetika collection.

**SCHIENALE IN METALLO**  
METAL BACKSPLASH

SP. 10 mm



**SISTEMA CADDY**  
CADDY SYSTEM



## BAIN

Accessori magnetici bagno componibili  
Modular bathroom magnetic accessories

**Portasciugamani (accessorio base)**  
Towel holder (basic accessory)

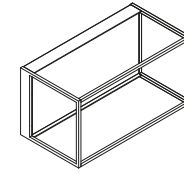

**Accessori opzionali**  
Optional accessories



**Ripiano in metallo**  
Metal shelf

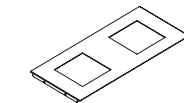

**Ripiano per accessori ceramica**  
Shelf for ceramic accessories



**Vasetto ceramica**  
Ceramic pot

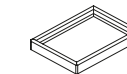

**Portasapone ceramica**  
Ceramic soap holder

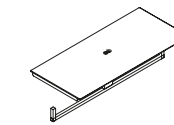

**Portarotolo doppio in metallo**  
Metal double roll holder

**Esempi di composizioni (portasciugamani + accessorio opzionale)**  
Composition examples (towel rail + optional accessory)

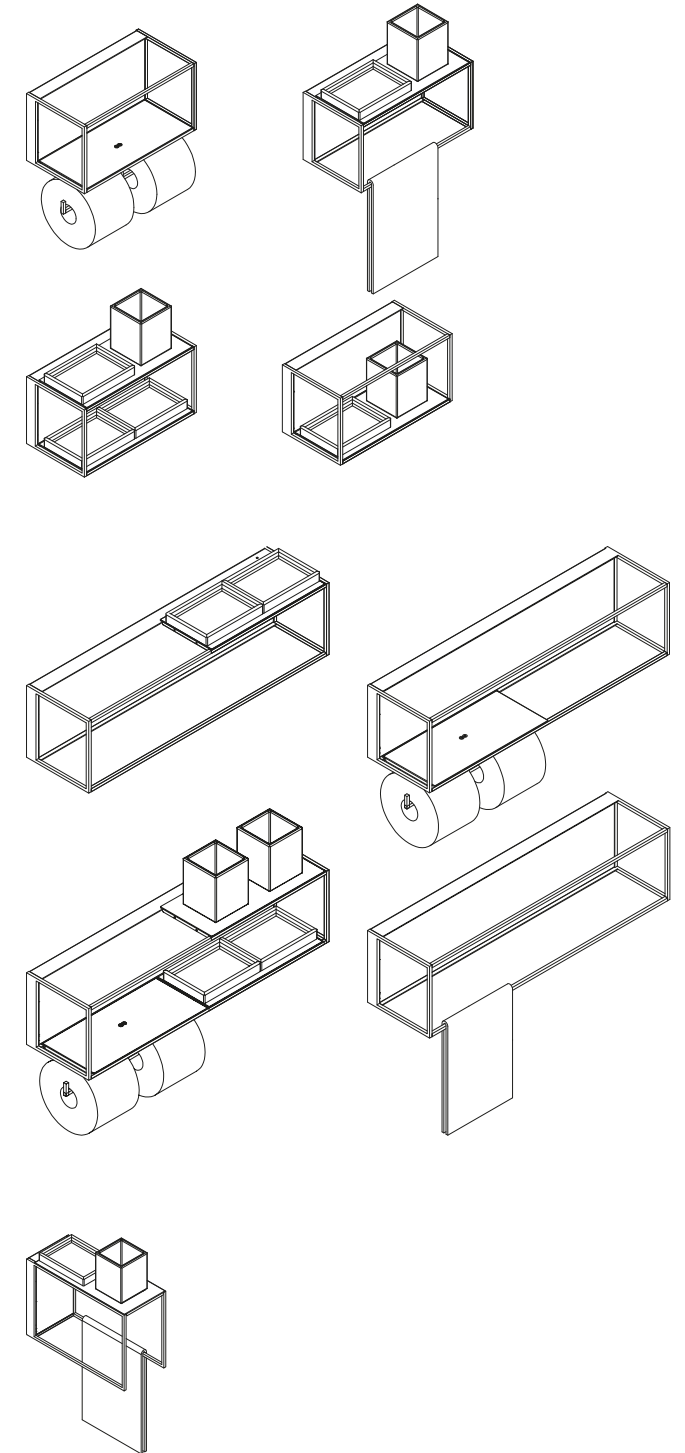

**Portarotolo singolo in metallo**  
Metal single roll holder

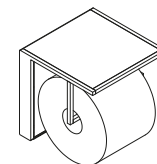

## SCHIENALI CUCINA

Gli schienali cucina di tipo **1.0** sono realizzati in metallo verniciato, in acciaio inossidabile oppure in fenix. Sugli schienali di tipo **1.0** si possono applicare tutti gli accessori e le mensole della collezione Magnetika.

1.0

Magneti base  
Basic magnets

## KITCHEN BACKSPASHES

The **1.0** kitchen backsplashes are made of painted metal, stainless steel or fenix. The **1.0** backsplashes can be combined with any accessory and shelf of the Magnetika collection.

## SCHIENALI CUCINA

Gli schienali cucina di tipo **2.0** sono realizzati in ceramica effetto marmo, vetro verniciato o retro-illuminato, specchio. Sugli schienali di tipo **2.0** si possono applicare solo gli accessori con magneti potenziati **2.0**.

2.0

Magneti potenziati  
Enhanced magnets

## KITCHEN BACKSPASHES

The **2.0** kitchen backsplashes are made of ceramic with marble effect, painted or back-lit glass, mirror. The **2.0** backsplashes can exclusively be combined with the **2.0** accessories, equipped with enhanced magnets.

SCHIENALE IN METALLO SP. 1,5 mm  
METAL BACKSPASH



SCHIENALE IN FENIX  
FENIX BACKSPASH



SCHIENALE IN METALLO SP. 10 mm  
METAL BACKSPASH



SISTEMA CADDY  
CADDY SYSTEM



SCHIENALE IN SPECCHIO  
MIRROR BACKSPASH



SCHIENALE IN VETRO LUMINOSO  
BACKLIT GLASS BACKSPASH



SCHIENALE IN VETRO  
GLASS BACKSPASH



SCHIENALE IN VETRO CON LED SUPERIORE  
GLASS BACKSPASH WITH TOP LED



### SCHIENALE IN METALLO SP. 1,5 mm

METAL BACKSPASH

Schienale in metallo verniciato o in ferro naturale con spessore 1,5 mm. Fissaggio a parete con viti in finitura a vista.  
Backsplash in painted metal or natural iron with a thickness of 1,5 mm. Wall fixing with visible screws in matching color.



Spessore - Thickness 1,5 mm

Possibilità di foro presa elettrica.  
Possibility of electric outlet hole.

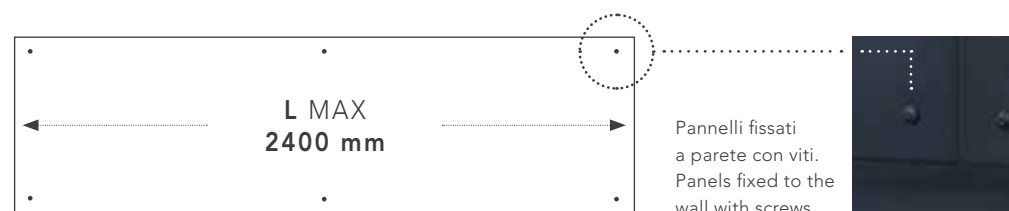

Finiture - Finishes



Bianco White Nero Black Titanio Titanium Grafite Graphite Ottone goffrato Embossed brass Rame goffrato Embossed copper Ferro naturale Natural iron

### SCHIENALE IN METALLO SP. 10 mm

METAL BACKSPASH

Schienale in metallo verniciato o in acciaio inox con spessore 10 mm. Fissaggio a parete con colla siliconica o aggancio posteriore con viti.  
Backsplash in painted metal or stainless steel with a thickness of 10 mm. Wall fixing with silicone glue or rear hooking with screws.



Spessore - Thickness 10 mm

Possibilità di foro presa elettrica.  
Possibility of electric outlet hole.



Finiture - Finishes



Bianco White Nero Black Titanio Titanium Grafite Graphite Ottone goffrato Embossed brass Rame goffrato Embossed copper Acciaio Inox Stainless steel

**SCHIENALE IN FENIX SP. 11 mm**

FENIX BACKSPLASH

Schienale magnetico in Fenix, con spessore 11 mm. Fissaggio a parete con colla siliconica o aggancio posteriore con viti. Profilo di finitura in alluminio per i bordi a vista.

Magnetic Fenix backsplash with a thickness of 11 mm. Wall fixing with silicone glue or rear hooking with screws. Finishing profile in aluminum for visible edges.



Spessore - Thickness **11 mm**

Possibilità di foro presa elettrica.  
Possibility of electric outlet hole.



Finiture - Finishes



Bianco  
White



Nero  
Black



Colori Fenix su richiesta  
Fenix colors on request

**SISTEMA CADDY SP. 20 mm**

CADDY SYSTEM

Sistema di pannelli modulari in metallo verniciato con spessore 20 mm. Fissaggio a parete su apposite cremagliere in dotazione. Possibilità di moduli sporgenti con illuminazione led inferiore e superiore.

Modular panel system in painted metal with a thickness of 20 mm. Wall fixing on special racks supplied. Projecting panels with upper and lower led lighting.



Spessore - Thickness **20 mm**

Moduli pannelli - Panel modules

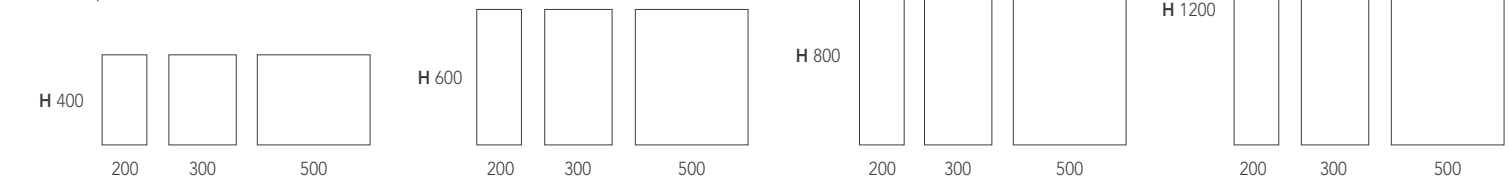

Finiture - Finishes



Bianco  
White



Nero  
Black



Titanio  
Titanium



Grafite  
Graphite



Ottone goffrato  
Embossed brass



Rame goffrato  
Embossed copper

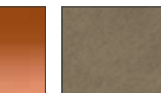

Peltro  
Pewter



Bronzo  
Bronze



Rame brunito  
Aged copper

**SCHIENALE IN CERAMICA SP. 17 mm**

CERAMIC BACKSPLASH

Schienale magnetico in ceramica con diverse finiture di marmo, con spessore 17 mm. Fissaggio a parete con colla siliconica o aggancio posteriore con viti. Profilo di finitura in alluminio per i bordi a vista. Abbinabile ad accessori magnetici potenziati 2.0.

Magnetic ceramic backsplash with various marble finishes, with a thickness of 17 mm. Wall fixing with silicone glue or rear hooking with screws. Finishing profile in aluminum for visible edges. Combinable with 2.0 enhanced magnetic accessories.



Spessore - Thickness 17 mm

Possibilità di foro presa elettrica.  
Possibility of electric outlet hole.



Finiture - Finishes



Bianco Calacatta Calacatta white  
Statuario Statuary  
Nero Marquinia Marquinia black  
Etoile crema Etoile cream

**SCHIENALE IN SPECCHIO SP. 17 mm**

MIRROR BACKSPLASH

Specchio magnetico con spessore 17 mm. Fissaggio a parete con colla siliconica o aggancio posteriore con viti. Profilo di finitura in alluminio per i bordi a vista. Abbinabile ad accessori magnetici potenziati 2.0.

Magnetic mirror backsplash with a thickness of 17 mm. Wall fixing with silicone glue or rear hooking with screws. Finishing profile in aluminum for visible edges. Combinable with 2.0 enhanced magnetic accessories.



Spessore - Thickness 17 mm

Possibilità di foro presa elettrica.  
Possibility of electric outlet hole.



Finiture - Finishes



Specchio Mirror  
Specchio Fumè Smoked mirror

### SCHIENALE IN VETRO SP. 17 mm

GLASS BACKSPLASH

Schienale magnetico in vetro retro-verniciato, con spessore 17 mm. Fissaggio a parete con colla siliconica o aggancio posteriore con viti. Profilo di finitura in alluminio per i bordi a vista. Abbinabile ad accessori magnetici potenziati 2.0.

Magnetic backsplash in back-painted glass, with a thickness of 17 mm. Wall fixing with silicone glue or rear hooking with screws. Finishing profile in aluminum for visible edges. Combinable with 2.0 enhanced magnetic accessories.



Spessore - Thickness **17 mm**

Possibilità di foro presa elettrica.  
Possibility of electric outlet hole.



Finiture - Finishes



Bianco  
White



Nero  
Black



Colori RAL su richiesta  
RAL colors on request

**SCHIENALE IN VETRO LUMINOSO SP. 20 mm**

LIGHT BACKSPASH

Schienale magnetico in vetro bianco illuminato con tecnologia LED a diffusione. Spessore 20 mm. Fissaggio a parete con sistema magnetico. Profilo perimetrale in alluminio. Abbinabile ad accessori magnetici potenziati 2.0.

Magnetic backsplash in white glass, lit with diffused LED technology. Thickness 20 mm. Wall fixing with magnetic system. Perimeter profile in aluminum. Combinable with 2.0 enhanced magnetic accessories.



Spessore - Thickness 20 mm



Finiture - Finishes



Bianco  
White

- **Luce dimmerabile**  
Dimmable light
- **Telecomando opzionale**  
Optional remote control

**SCHIENALE IN VETRO CON LED SUPERIORE SP. 20 mm**

GLASS BACKSPASH WITH TOP LED

Schienale magnetico in vetro bianco di spessore 20 mm con led superiore. Profilo in alluminio grigio sul bordo superiore, fissaggio a parete con sistema magnetico. Abbinabile ad accessori magnetici potenziati 2.0.

White glass backsplash 20 mm thick with top led. Grey aluminum profile on the upper edge, wall mounting with magnetic system. Combinable with 2.0 enhanced magnetic accessories.



Spessore - Thickness 20 mm



Finiture - Finishes



Bianco  
White

- **Luce dimmerabile**  
Dimmable light
- **Telecomando opzionale**  
Optional remote control



**CAREN**

Design: Ronda Design Lab, Marco Fumagalli

Accessori magnetici da cucina in acciaio o metallo verniciato. Con magneti standard 1.0 oppure con magneti potenziati 2.0 per utilizzo su schienali in ceramica e vetro.

Magnetic kitchen accessories in stainless steel or painted metal. With standard 1.0 magnets or with enhanced 2.0 magnets for ceramic and glass backsplashes.



**1.0**  
Magneti base  
Basic magnets



**2.0**  
Magneti potenziati  
Enhanced magnets

Finiture - Finishes



Bianco  
White



Nero  
Black



Titanio  
Titanium



Grafite  
Graphite



Ottone goffrato  
Embossed brass



Rame goffrato  
Embossed copper



Acciaio Inox  
Inox steel



**PORTATAZZE**  
MUG HOLDER  
Portatazze magnetico in metallo.  
Metal magnetic mug holder.  
Dimensioni \_Dimensions  
L 298 P 42 H 73 mm  
Portata\_ Load capacity  
3 Kg

1.0



**PORTAVASI**  
VASES HOLDER  
Portavasi magnetico in metallo con tre vasi in plexiglass.  
Metal magnetic vase holder with 3 plexiglass vases.  
Dimensioni \_Dimensions  
L 298 P 105 H 93 mm  
Portata\_ Load capacity  
3 Kg

1.0



**PORTAROTOLI**  
PAPER ROLL HOLDER  
Portarotoli magnetico in metallo.  
Metal magnetic paper roll holder.  
Dimensioni \_Dimensions  
L 298 P 168 H 162 mm  
L 298 P 168 H 192 mm  
Portata\_ Load capacity  
3 Kg

1.0 2.0



**MENSOLA**  
SHELF  
Mensola magnetica in metallo.  
Metal magnetic shelf.  
Dimensioni \_Dimensions  
L 298 P 104 H 73 mm  
L 298 P 104 H 103 mm  
Portata\_ Load capacity  
3 Kg

1.0 2.0



**PORTAMESTOLI**  
SPOON RACK  
Portamestoli magnetico in metallo.  
Metal magnetic spoon rack.  
Dimensioni \_Dimensions  
L 298 P 42 H 73 mm  
Portata\_ Load capacity  
3 Kg

1.0



**PORTACOLTELLI**  
KNIVES RACK  
Portacoltelli magnetico in metallo.  
Metal magnetic knives holder.  
Dimensioni \_Dimensions  
L 298 P 77 H 80 mm  
Portata\_ Load capacity  
3 Kg

1.0



**BARATTOLO MULTIFUNZIONE**  
MULTIFUNCTIONAL JAR  
Barattolo magnetico in metallo.  
Metal magnetic jar.  
Dimensioni \_Dimensions  
L 116 P 115 H 106 mm  
L 116 P 115 H 136 mm  
Portata\_ Load capacity  
3 Kg

1.0 2.0



**GANCIO A FASCIA**  
HOOK BAND  
Gancio magnetico in metallo.  
Metal magnetic hook.  
Dimensioni \_Dimensions  
L 298 P 27 H 93 mm  
L 298 P 27 H 123 mm  
Portata\_ Load capacity  
3 Kg

1.0 2.0



**GANCIO**  
HOOK  
Gancio magnetico in metallo.  
Metal magnetic hook.  
Dimensioni \_Dimensions  
L 40 P 27 H 93 mm  
Portata\_ Load capacity  
1 Kg

1.0

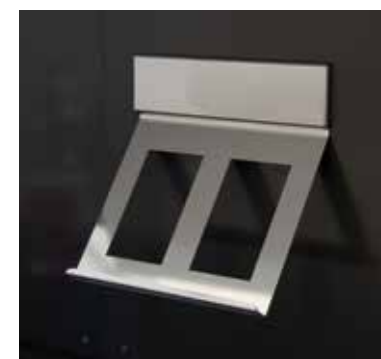

**PORTATABLLET**  
TABLET HOLDER  
Portatabllet magnetico in metallo.  
Metal magnetic tablet holder.  
Dimensioni \_Dimensions  
L 245 P 132 H 260 mm

1.0



**GANCIO TRIPLO**  
TRIPLE HOOK  
Gancio magnetico in metallo.  
Metal magnetic hook.  
Dimensioni \_Dimensions  
L 128 P 27 H 93 mm  
Portata\_ Load capacity  
3 Kg

1.0



**PORTABARATTOLI**  
JAR HOLDER  
Portabarattoli magnetico in metallo.  
Metal magnetic jar holder.  
Dimensioni \_Dimensions  
L 298 P 104 H 80 mm  
L 298 P 104 H 110 mm  
Portata\_ Load capacity  
3 Kg

1.0 2.0

**PRYSMA**

Design: Studio 28

Accessori magnetici da cucina in metallo verniciato con magneti potenziati di tipo 2.0.

Magnetic kitchen accessories in painted metal with enhanced magnets of type 2.0.

**2.0**

Magneti potenziati  
Enhanced magnets



**PORTAROTOLI**  
ROLL HOLDER  
Portarotoli magnetico.  
Magnetic roll holder.

Dimensioni \_Dimensions  
L 290 P 85 H 90 mm

Portata\_ Load capacity  
3 Kg

**2.0**



**BARRA PORTAMESTOLI**  
LADLE HOLDER BAR  
Barra portamestoli magnetica.  
Magnetic ladle.

Dimensioni \_Dimensions  
L 290 P 85 H 90 mm

Portata\_ Load capacity  
3 Kg

**2.0**



**MENSOLA**  
SHELF  
Mensola magnetica.  
Magnetic shelf.

Dimensioni \_Dimensions  
L 290 P 120 H 90 mm

Portata\_ Load capacity  
3 Kg

**2.0**



**VASCHETTA PICCOLA**  
SMALL BOWL  
Contenitore magnetico porta mestoli  
o porta bottiglia.  
Magnetic container for ladles  
or bottle.

Dimensioni \_Dimensions  
L 150 P 120 H 150 mm

Portata\_ Load capacity  
3 Kg

**2.0**



**VASCHETTA GRANDE**  
BIG BOWL  
Vaschetta grande magnetica.  
Magnetic big bowl.

Dimensioni \_Dimensions  
L 290 P 120 H 90 mm

Portata\_ Load capacity  
3 Kg

**2.0**

Finiture - Finishes



Bianco White    Nero Black    Titanio Titanium    Grafite Graphite    Ottone gofrato Embossed brass    Rame gofrato Embossed copper

**CADDY**

Design: Studio 28

Mensole magnetiche in metallo verniciato.  
Disponibili nella versione chiusa Swing e aperta Cart.  
Magnetic shelves in painted metal.  
Available as a closed shelf Swing or an open shelf Cart.



**SWING**  
**VASCHETTA \_ POT**  
Contenitore magnetico in metallo verniciato.  
Magnetic container in varnished metal.  
**Dimensioni \_Dimensions**  
L 200 P 162 H 200 mm  
**Portata\_ Load capacity**  
7 Kg

1.0 2.0



**CART**  
**MENSOLA \_ SHELF**  
Mensola magnetica in metallo verniciato.  
Magnetic shelf in varnished metal.  
**Dimensioni \_Dimensions**  
L 200 P 162 H 200 mm  
**Portata\_ Load capacity**  
7 Kg

1.0 2.0



**SWING**  
**VASCHETTA \_ POT**  
Contenitore magnetico in metallo verniciato.  
Magnetic container in varnished metal.  
**Dimensioni \_Dimensions**  
L 300 P 162 H 200 mm  
**Portata\_ Load capacity**  
10 Kg

1.0 2.0



**CART**  
**MENSOLA \_ SHELF**  
Mensola magnetica in metallo verniciato.  
Magnetic shelf in varnished metal.  
**Dimensioni \_Dimensions**  
L 300 P 220 H 350 mm  
**Portata\_ Load capacity**  
10 Kg

1.0 2.0



**SWING**  
**VASCHETTA \_ POT**  
Contenitore magnetico in metallo verniciato.  
Magnetic container in varnished metal.  
**Dimensioni \_Dimensions**  
L 500 P 162 H 120 mm  
**Portata\_ Load capacity**  
10 Kg

1.0 2.0



**CART**  
**MENSOLA \_ SHELF**  
Mensola magnetica in metallo verniciato.  
Magnetic shelf in varnished metal.  
**Dimensioni \_Dimensions**  
L 500 P 162 H 120 mm  
**Portata\_ Load capacity**  
10 Kg

1.0 2.0

**Finiture - Finishes**

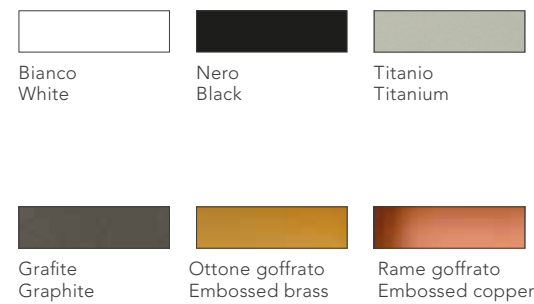

**CART**  
**MENSOLA \_ SHELF**  
Mensola magnetica in metallo verniciato.  
Magnetic shelf in varnished metal.  
**Dimensioni \_Dimensions**  
L 500 P 220 H 300 mm  
**Portata\_ Load capacity**  
10 Kg

1.0 2.0

**BATHROOM**

Design: Ferruccio Tasinato

Accessori magnetici per bagno in metallo verniciato.  
Magnetic bathroom accessories in painted metal.

Finiture - Finishes

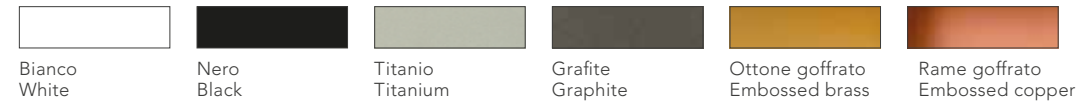

Magneti base  
Basic magnets



**SISTEMA MAGNETICO**  
MAGNETIC SYSTEM



**PORTAFIORE**  
FLOWER HOLDER  
Portfiore magnetico.  
Magnetic flower holder.  
Dimensioni \_Dimensions  
L 30 P 30 mm  
Portata\_ Load capacity  
1 Kg



**PORTASALVIETTE PICCOLO**  
SMALL TOWEL RAIL  
Portasalviette magnetico.  
Magnetic towel rail.  
Dimensioni \_Dimensions  
L 240 P 60 H 60 mm  
Portata\_ Load capacity  
2 Kg



**PORTASALVIETTE GRANDE**  
LARGE TOWEL RAIL  
Portasalviette magnetico.  
Magnetic towel rail.  
Dimensioni \_Dimensions  
L 480 P 90 H 60 mm  
Portata\_ Load capacity  
3 Kg



**CONTENITORE**  
CASE  
Contenitore magnetico.  
Magnetic case.  
Dimensioni \_Dimensions  
L 300 P 120 H 150 mm  
Portata\_ Load capacity  
2 Kg



**CONTENITORE**  
CASE  
Contenitore magnetico.  
Magnetic case.  
Dimensioni \_Dimensions  
L 300 P 120 H 150 mm  
Portata\_ Load capacity  
2 Kg



**PORTAGIOIE**  
JEWELRY CASE  
Portagioie magnetico.  
Magnetic jewelry case.  
Dimensioni \_Dimensions  
L 240 P 60 H 60 mm  
Portata\_ Load capacity  
2 Kg



**PORTAROTOLO**  
TOILET PAPER HOLDER  
Portarotolo magnetico.  
Magnetic toilet paper holder.  
Dimensioni \_Dimensions  
L 150 P 90 H 60 mm  
Portata\_ Load capacity  
1 Kg



**BAIN - BATHROOM COLLECTION**

Design: Studio 28

Accessori magnetici per bagno in metallo verniciato.  
Magnetic bathroom accessories in painted metal.

**Finiture - Finishes**

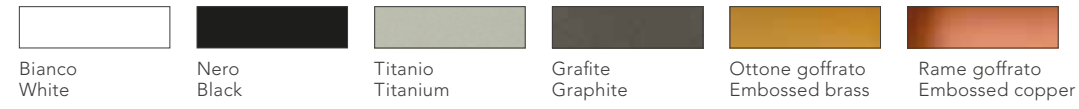

**2.0**

Magneti potenziati  
Enhanced magnets



**BAIN**  
Accessori magnetici bagno componibili  
Modular bathroom magnetic accessories

**Portasciugamani (accessorio base)**  
Towel holder (basic accessory)

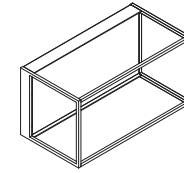

**Accessori opzionali**  
Optional accessories

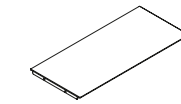

**Ripiano in metallo**  
Metal shelf

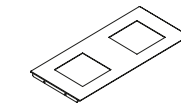

**Ripiano per accessori ceramica**  
Shelf for ceramic accessories



**Vasetto ceramica**  
Ceramic pot

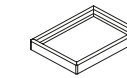

**Portasapone ceramica**  
Ceramic soap holder

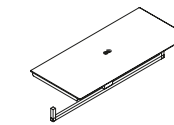

**Portarotolo doppio in metallo**  
Metal double roll holder

**Esempi di composizioni (portasciugamani + accessorio opzionale)**  
Composition examples (towel rail + optional accessory)

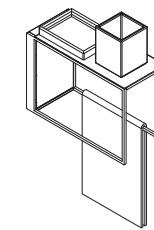
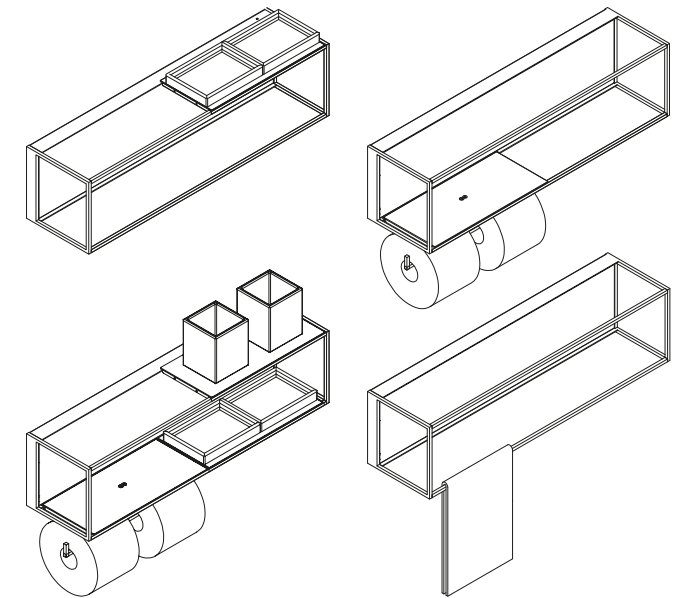
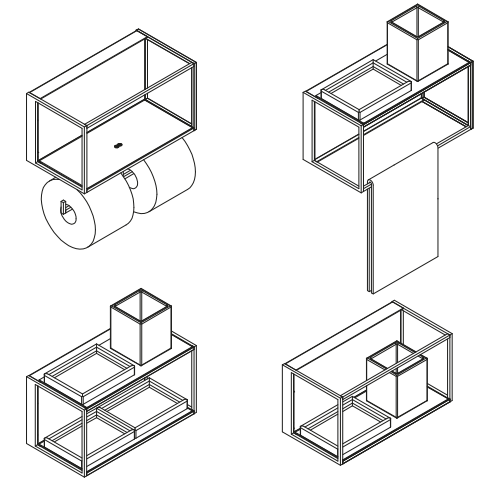

**Portarotolo singolo in metallo**  
Metal single roll holder

